

INTRODUCTION

System Features

Features of the Jensen DV2011 mobile audio system include:

- 3-Wire power (ACC, Batt, Gnd)
- Detachable faceplate
- 1-DIN (sleeve-mount) chassis design
- Segmented LCD Display
- Blue LED panel illumination
- Electronic AM/FM tuner (US)
- Station presets (18FM, 12AM)
- Auto-Store (AS)/ Preset Scan (PS)
- Single DVD / CD player (Plays DVD, CD-A, CD-R/RW Media)
- Plays MP3 and WMA Encoded Discs
- Electronic Skip Protection (ESP) CD (8 Sec) DVD (3 Sec)
- Front panel Aux Video / Stereo Audio input (3.5mm)
- Encoded rotary volume control
- Audio Mute / Loudness
- Preset EQ (Pop, Rock, Classic)
- Stereo Pre-amp Audio Output (Front and Rear RCA)
- 2 Composite Video Output (RCA)
- 1 Composite Video Input (RCA)
- 4x40W Maximum Audio Power Output
- Subwoofer Output (Pre-amp RCA)
- Wireless (Jensen IR Codes) Credit Card size remote control (included)
- Wired remote ready (MWR75 sold separately)
- IR repeater eye ready (IRPMRPT sold separately)
- Regulatory Certifications: FCC

Content List

- Jensen Heavy Duty Radio
- Hardware Kit
- Installation Manual
- Quick reference Guide

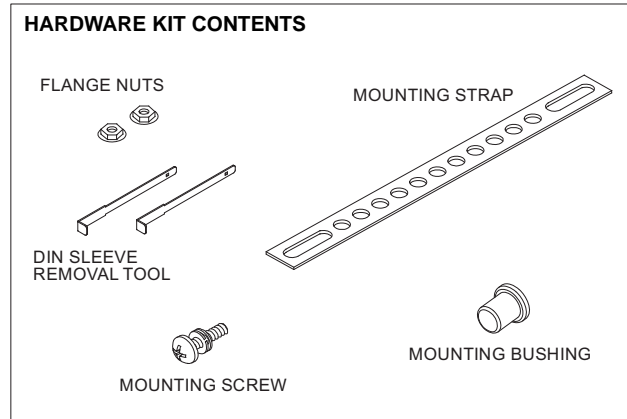

SAFETY INFORMATION

When Driving

Keep the volume level low enough to be aware of the road and traffic conditions.

When Washing your Vehicle

Do not expose the product to water or excessive moisture. Moisture can cause electrical shorts, fire or other damage.

When Parked

Parking in direct sunlight can produce very high temperatures inside your vehicle. Give the interior a chance to cool down before starting playback.

Use the Proper Power Supply

This product is designed to operate with a 12 volt DC negative ground battery system (the standard system in a North American vehicle).

Protect the Disc Mechanism

Avoid inserting any foreign objects into the disc slot. Misuse may cause malfunction or permanent damage due to the precise mechanism of this unit.

CAUTION:

THIS MOBILE DVD PLAYER IS A CLASS I LASER PRODUCT. THIS UNIT USES A VISIBLE/ INVISIBLE LASER BEAM WHICH COULD CAUSE HAZARDOUS RADIATION IF EXPOSED DIRECTLY. BE SURE TO OPERATE THE MOBILE DVD PLAYER AS INSTRUCTED.

USE OF CONTROLS OR ADJUSTMENTS OR PERFORMANCE OR PROCEDURES OTHER THAN THOSE SPECIFIED HEREIN MAY RESULT IN HAZARDOUS RADIATION EXPOSURE. DO NOT OPEN COVERS AND DO NOT REPAIR BY YOURSELF. PLEASE REFER SERVICING TO A QUALIFIED TECHNICIAN.

WARNING:

- TO REDUCE THE RISK OF FIRE OR ELECTRIC SHOCK, DO NOT EXPOSE THIS EQUIPMENT TO RAIN OR MOISTURE.
- TO REDUCE THE RISK OF FIRE OR ELECTRIC SHOCK AND ANNOYING INTERFERENCE, USE ONLY THE RECOMMENDED ACCESSORIES.
- THIS DEVICE IS INTENDED FOR CONTINUOUS OPERATION.

This product incorporates copyright protection technology that is protected by method claims of certain U.S. Patents and other intellectual property rights owned by Macrovision Corporation and other rights owners. Use of this copyright protection technology must be authorized by Macrovision Corporation, and is intended for home and other limited viewing uses only unless otherwise authorized by Macrovision Corporation. Reverse engineering or disassembly is prohibited.

Region Management Information

This Mobile DVD Player is designed and manufactured to respond to the Region Management Information recorded on individual DVD discs. If the Region number described on the DVD disc does not correspond to the Region number(s) supported by this Mobile DVD Player, the disc will not play in this unit.

DISC NOTES

Compatible Disc Types

DVD Video

DVDs contain excellent sound and video quality due to Dolby Digital and MPEG2 encoding. A DVD is 12 cm in diameter and can hold more than seven times the data of a CD-ROM. The maximum playing time can be up to 2 hours (a double-sided DVD is up to 4 hours). There are four types of DVD discs: single-layer single-sided (1), two-layer single-sided (2), single-layer double-sided (3), and two-layer double-sided (4).

CD-DA

CD-DA discs can play voice data. The playing time of the standard 12 cm CD-DA disc is 74 minutes.

DTS-CD

The DTS digital surround sound uses 6 digital sound tracks to replace the analog voice tracks in movies.

HDCD

HDCD, or "High Definition Compatible Digital," is a recording/playing technology that improves CD audio quality. Based on full compliance with CD specifications, it can enhance the quality and quantity of digital sounds in the highest scale. It encodes the required messages that were deserted by the CD format, and stores the related commands into the LSB. Without changing the CD format, it is output through the 24-bit D/A converter, which will ultimately enhance the quality of playback.

MP3/WMA/JPEG

This unit is compatible with CD-R, CD-RW, and CD-ROM discs containing MP3, WMA, and JPEG tracks.

CD-R/CD-RW

This unit is compatible with CD-R and CD-RW discs that support ISO9660 specifications. ".MP3", ".JPG", ".JPEG", ".AC3", ".PCM", ".MPG", ".MPE", and ".WAV" formats can be included on ISO9660-compatible discs.

DVD-R / DVD-RW

This unit is compatible with DVD-R and DVD-RW discs that support UDF specifications. ".MP3", ".JPG", ".JPEG", ".AC3", ".PCM", ".MPG", ".MPE", and ".WAV" formats can be included on UDF-compatible discs.

Incompatible Disc Types

- 8 cm disc
- CD ROM
- CDV, CDI, CDG

- LD
- DVD ROM
- DVD RAM

NOTE: DVD-R and DVD-RW discs will not play unless the recording session is closed and the DVD is finalized.

Table 1: General Disc Information

Disc Type	Logo	Diameter/ Playable Sides	Playback Time
DVD Video		12 cm single/double side (1 layer & 2 layer)	133 minutes (4.7 GB) 242 minutes (8.5 GB) 266 minutes (9.4 GB) 484 minutes (17 GB)
Audio CD		12 cm single side	74 minutes
MP3/WMA Disc		CD-Rs or CD-RWs recorded in MP3, MPEG1 or 2, 2.5 Audio Layer 3 and WMA Version 7 and 8. The recorded format must be compliant with ISO 9660 Level 1, ISO 9660 Level 2, Romeo, or Joliet.	

Disc Maintenance

Before playing, wipe the disc using a clean cloth, working from the center hole towards the outside edge.

Never use benzene, thinners, cleaning fluids, anti-static liquids or any other solvent.

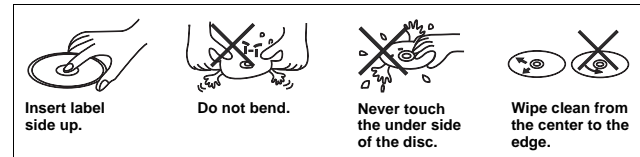

NOTE: A disc may become scratched (although not enough to make it unusable) depending on how you handle it and other conditions in the usage environment. These scratches are not an indication of a problem with the player.

INSTALLATION

This unit can be properly installed with either a "Front" (conventional DIN front mount) or "Rear" (DIN rear mount installation, utilizing threaded screw holes at the sides of the unit chassis) mount. For details, refer to installation methods A and B.

Before You Begin

- Disconnect Battery**
Before you begin, always disconnect the battery negative terminal.
- Remove Transport Screws**

Important Notes

- Before final installation, test the wiring connections to make sure the unit is connected properly and the system works.
- Use only the parts included with the unit to ensure proper installation. The use of unauthorized parts can cause malfunctions.
- Consult with your nearest dealer if installation requires the drilling of holes or other modifications to your vehicle.
- Install the unit where it does not interfere with driving and cannot injure passengers if there is a sudden or emergency stop.
- If the installation angle exceeds 30° from horizontal, the unit might not give optimum performance.
- Avoid installing the unit where it will be subject to high temperatures from direct sunlight, hot air, or from a heater, or where it would be subject to excessive dust, dirt or vibration.
- Be sure to remove the control panel before installing the unit.

DIN Front Mount (Method A)

- Slide the mounting sleeve off of the chassis if it has not already been removed. If it is locked into position, use the removal keys (supplied) to disengage it. The removal keys are depicted in "DIN Rear Mount (Method B)" on page 5.
- Check the dashboard opening size by sliding the mounting sleeve into it. If the opening is not large enough, carefully cut or file as necessary until the sleeve easily slides into the opening. Do not force the sleeve into the opening or cause it to bend or bow. Check that there will be sufficient space behind the dashboard for the radio chassis.
- Locate the series of bend tabs along the top, bottom and sides of the mounting sleeve. With the sleeve fully inserted into the dashboard opening, bend as many of the tabs outward as necessary to firmly secure the sleeve to the dashboard.
- Place the radio in front of the dashboard opening so the wiring can be brought through the mounting sleeve.

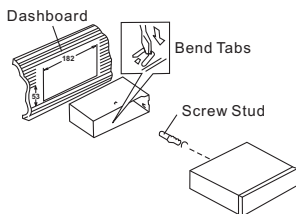

- Follow the wiring diagram carefully and make certain all connections are secure and insulated with crimp connectors or electrical tape to ensure proper operation.
- After completing the wiring connections, turn the unit on to confirm operation (vehicle accessory switch must be on). If the unit does not operate, recheck all wiring until the problem is corrected. Once proper operation is achieved, turn the accessory switch off and proceed with final mounting of the chassis.
- Carefully slide the radio into the mounting sleeve making sure it is right-side-up until it is fully seated and the spring clips lock it into place.
- Attach one end of the perforated support strap (supplied) to the screw stud on the rear of the chassis using the hex nut provided. Fasten the other end of the perforated strap to a secure part of the dashboard either above or below the radio using the screw and plain washer provided. Bend the strap, as necessary, to position it. Some vehicle installations provide cavity for rear support. In these applications, place the rubber bushing over the screw stud and insert the radio.

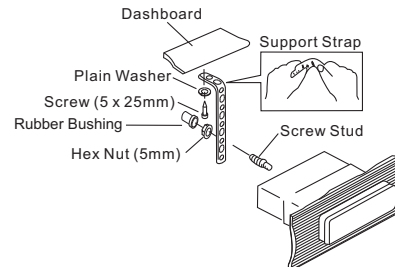

- CAUTION: The perforated rear support strap or rear rubber mounting bushing must be used in the installation of the radio. Installation without either may result in damage to the radio or the mounting surface and void the manufacturer's warranty.**
- Test radio operation by referring to the operating instructions for the unit.
 - When wiring is complete, reconnect the battery negative terminal.
 - Push the trim plate against the chassis until it is fitted. **You must do this before you install the control panel, otherwise it can't be attached.**

DIN Rear Mount (Method B)

This unit has threaded holes in the chassis side panels which may be used with the original factory mounting brackets of some vehicles to mount the radio to the dashboard. Please consult with your local mobile stereo shop for assistance on this type of installation.

- Remove the existing factory radio from the dashboard or center console mounting. Save all hardware and brackets as they will be used to mount the new radio.
- Carefully unsnap the plastic trim ring from the front of the new radio chassis. Remove and discard the trim ring.

3. Remove the factory mounting brackets and hardware from the existing radio and attach them to the new radio. Select a position where the screw holes of the bracket and the screw holes of the main unit are aligned (are fitted). Tighten the screws at 2 places on each side. Do not exceed M5 x 9 MM maximum screw size. Longer screws may damage components inside the chassis.
4. Wire the new radio to the vehicle as outlined in the Universal Installation instructions.
5. When wiring is complete, reconnect the battery negative terminal.
6. Mount the new radio assembly to the dashboard or center console using the reverse procedure of step 1.

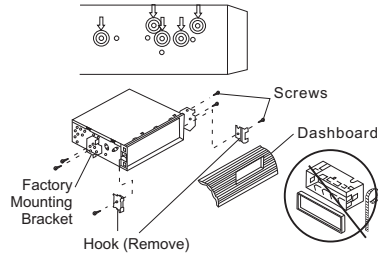

NOTE: The mounting box, outer trim ring, and half-sleeve are not used for method B installation.

Removing the Unit (Method A Installation)

To remove the radio after installation:

1. Insert fingers into the groove in the front of frame and pull out to remove the frame. (When re-attaching the frame, point the side with a groove downwards and re-attach.)
2. Insert the removal keys straight back until they click, and then pull the radio out. If removal keys are inserted at an angle, they will not lock properly to release the unit.

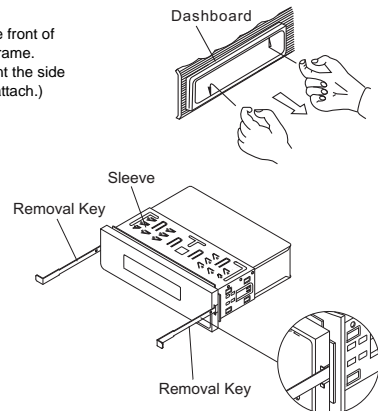

Detachable Control Panel (DCP)

Removing the Detachable Control Panel (DCP)

1. Turn the power off.
2. Press the REL button.
3. Remove the DCP.

Attaching the DCP

1. Attach the panel at the right side first, with point B on the main unit touching point A on the DCP (as shown in the diagram).
2. Press the left side of the DCP onto the main unit until a "click" is heard.

CAUTION:

- **DO NOT** insert the DCP from the left side. Doing so may damage it.
- The DCP can easily be damaged if dropped or subjected to a strong shock. When the release button is pressed and the DCP is unlocked, the vehicle's vibrations may cause it to fall. To prevent damage to the DCP, always store it in a protective case after detaching it.
- The rear connector that connects the main unit and the DCP is an extremely important part. Be careful not to damage it by pressing on it with fingernails, pens, screwdrivers, etc.
- If the DCP is dirty, remove debris with a soft, dry cloth only. You can use a cotton swab soaked in isopropyl alcohol to clean the socket on the back of the DCP.

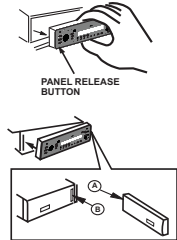

WIRING

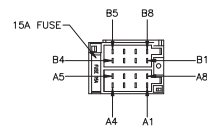
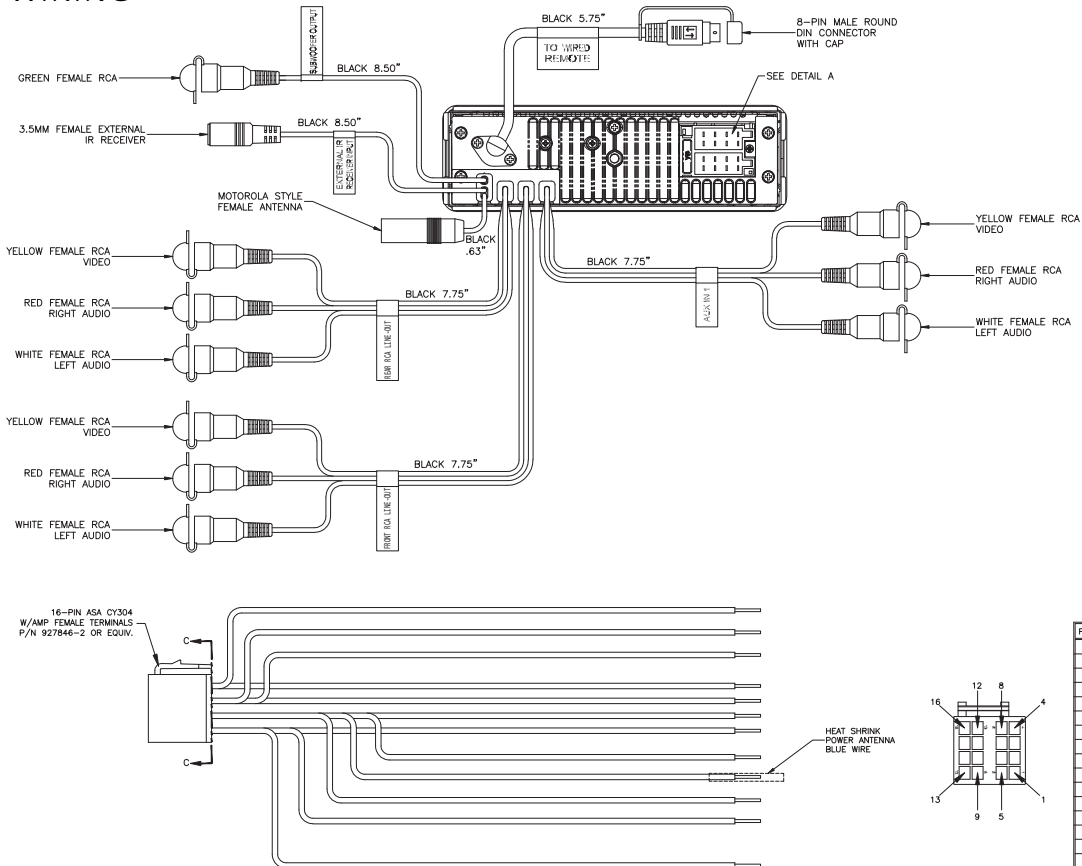

DETAIL A
SHOWN FROM PIN VIEW

PIN NO.	DESCRIPTION
A1	RIGHT REAR SPEAKER (+)
A2	RIGHT FRONT SPEAKER (+)
A3	LEFT FRONT SPEAKER (+)
A4	LEFT REAR SPEAKER (+)
A5	LEFT REAR SPEAKER (-)
A6	LEFT FRONT SPEAKER (-)
A7	RIGHT FRONT SPEAKER (-)
A8	RIGHT REAR SPEAKER (-)
B1	NO CONNECTION
B2	NO CONNECTION
B3	POWER ANTENNA REMOTE
B4	+12V SWITCHED
B5	GROUND
B6	NO CONNECTION
B7	+12V BATT UNSWITCHED
B8	NO CONNECTION

VIEW C-C
WIRE INSERTION VIEW

PIN NO.	WIRE COLOR	FUNCTION
1	GREEN	LEFT REAR SPEAKER (+)
2	WHITE	LEFT FRONT SPEAKER (+)
3	GRAY	RIGHT FRONT SPEAKER (+)
4	VIOLET	RIGHT REAR SPEAKER (+)
5	GREEN/BLACK	LEFT REAR SPEAKER (-)
6	WHITE/BLACK	LEFT FRONT SPEAKER (-)
7	GRAY/BLACK	RIGHT FRONT SPEAKER (-)
8	VIOLET/BLACK	RIGHT REAR SPEAKER (-)
9	RED	+12V SWITCHED
10	BLUE	POWER ANTENNA REMOTE
11	EMPTY	NO CONNECTION
12	EMPTY	NO CONNECTION
13	BLACK	GROUND
14	EMPTY	NO CONNECTION
15	YELLOW	+12V BATT UNSWITCHED
16	EMPTY	NO CONNECTION

CONTROLS AND INDICATORS

The buttons located on the unit and the remote control that perform the same function are assigned the same number for reference on the diagrams and in the text.

Front Panel Operation

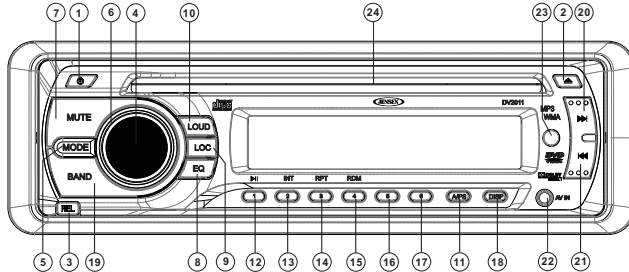

1. Power
2. Eject
3. Front Panel Release
4. Audio Control Button
5. Mode/Source Select
6. Volume Control Knob
7. Mute
8. Preset Equalizer
9. Local/Distant Reception Setting
10. Loudness Boost Setting
11. Auto Store/Preset Scan
12. Preset 1, Play/Pause
13. Preset 2, Intro Scan
14. Preset 3, Repeat Play
15. Preset 4, Random Play
16. Preset 5
17. Preset 6
18. Clock Display

19. Band Select
20. Fast Forward/Advance Chapter
21. Rewind/Previous Chapter
22. Auxiliary Input (AUX IN2)
23. Infrared Sensor
24. Disc Slot







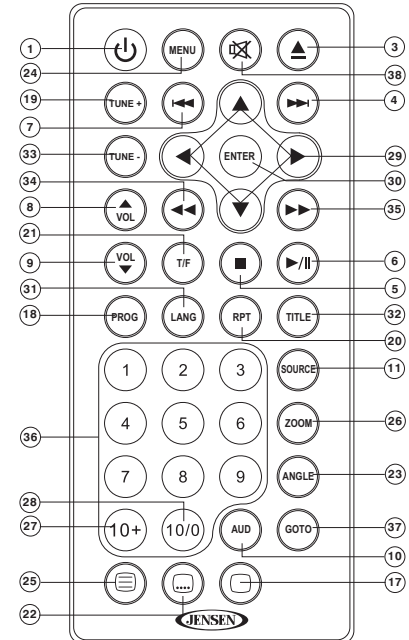

Remote Control Operation

Using the Remote Control

Point the remote control towards the player front face remote sensor IR (2). The operation angle is approximately 30 degrees in each direction of the front of the remote sensor.



Remote Control Functions

Ref #	Button	Function
1	 /POWER	Turn the unit ON or OFF
3	 /EJECT	Eject the disc
4	 /TRACK	Skip to the next track/chapter
5		Stop disc playback
6		Play/pause the disc (for disc play mode)
7	 /TRACK	Go to previous track/chapter
8	VOL \wedge	Increase the volume level
9	VOL \vee	Decrease the volume level
10	AUDIO	Select the desired adjustment mode (BASS, TREBLE, BALANCE, FADE).
11	SOURCE	Change between tuner, disc (DVD/VCD/CD/MP3) play mode and AUX IN1 or AUX IN2 mode
17		Display statistical disc information during playback
18	PROG	Display programmed playback screen, allowing you to enter tracks to play in programmed order.
19	TUNE+	Tune up one step
20	RPT	Repeat current track/chapter
21	T/F	<i>Press and hold</i> to set clock. Use the audio control knob to adjust hours. Press to move to minutes and turn to adjust.
22		Change the SUBTITLE language on multi-subtitle language DVD discs
23	ANGLE	Change the viewing angle on multi-angle DVD discs
24	MENU (PBC)	Display the root menu stored on DVD discs/Switch between PBC ON and PBC OFF on VCD discs
25		Display the SETUP menu
26	ZOOM	Increase the picture size
27	10+	Feature not used on this model
28	10/0	
29	\leftarrow , \rightarrow , \wedge , \vee	Select items left/right and ahead/back in menu mode
30	ENTER	Confirm selection of track/chapter
31	LANG	Change the audio sound track on multi-audio sound track DVD discs. Change the sound mode of VCD discs

Ref #	Button	Function
32	TITLE	Display the TITLE menu stored on DVD disc
33	TUNE-	Tune down one step
34	\ll /TRACK	Search in reverse rapidly
35	\gg /TRACK	Search forward rapidly
36	0-9	Enter track/chapter number directly. Use GOTO to search.
37	GOTO	Used with numeric buttons to search disc
38		Press to mute/resume audio.

BASIC OPERATION

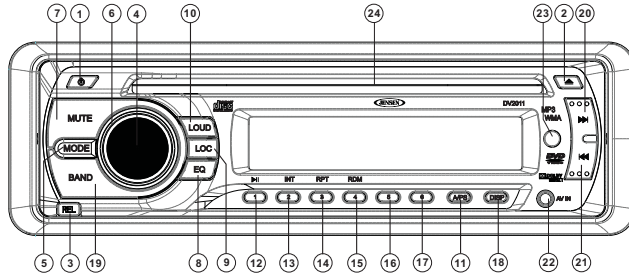

Control Panel Release (REL)

Press the REL button (3) to remove the control panel.

Power On/Off (⏻)

Press the ⏻ button (1) on the front of the unit ON or OFF.

Volume Control

To increase the volume, rotate the audio control knob (6) clockwise.

To decrease the volume, rotate the audio control knob counter clockwise. When the volume is adjusted, the volume level is shown on the display panel as a number ranging from "0" (lowest) to "39" (highest).

Mute

Press the MUTE button (7) to mute the audio output. "MUTE" will appear on the display. Press MUTE again to restore the audio output to the previous level.

Mode

Press the MODE button (5) to select a different mode of operation, as indicated on the display panel. Available modes include Tuner, DVD, AUX IN1 (OPTIONAL) and AUX IN2 (OPTIONAL).

Equalizer (EQ)

The preset equalizer applies preset sound effects to the unit's audio output signal. To adjust the preset equalizer, press the EQ button (8). Press repeatedly to choose between the following modes: OFF, POP, ROCK, CLAS.

Area (EQ)

Press and hold the EQ button (8) to select the appropriate frequency spacing for your area: USA or EU (Europe).

Loudness (LOUD)

When listening to music at low volume levels, this feature will boost the bass and treble ranges to compensate for the characteristics of human hearing. Press the LOUD button (10) to activate this feature. "LOUD ON" appears on the display panel. Press the LOUD button again to turn the LOUD function off.

Subwoofer (LOUD)

Press and hold the LOUD button (10) to turn the subwoofer function on/off.

Local/Distant (LOC)

Press the LOC button (9) to choose between Local (LOC) or Distance (DX) mode. This feature is used to designate the strength of the signals at which the radio will stop during automatic tuning. "Distance" is the default setting, allowing the radio to stop at a broader range of signals. To set the unit to select only strong local stations during automatic tuning, press the LOC button until "LOC" appears in the display.

Display Selector (DISP)

This unit can display either the clock time or radio frequency/CD player functions. Press the DISP button (18) to display the time. The correct time of day can be set by pressing and holding the DISP button.

Setting the Clock (DISP)

To set the clock, perform the following steps:

1. Press the DISP button (18) to display the clock.
2. Press and hold the DISP button (18) until the time display flashes.
3. Within 5 seconds, turn the audio control knob (6) to adjust the hour to the desired setting.
4. Press the audio control knob (4) to move to the minutes field.
5. Turn the audio control knob to adjust the minutes to the desired setting.
6. Press the DISP button again to return to radio frequency or disc play and normal operation will resume automatically.

Auxiliary Input Operation

You can connect another audio/video system to the unit through the AUX IN 1 terminals on the back (AUX IN1) or front panel AV IN (AUX IN2) of the unit. Once the device is connected, press the MODE button (5) on the front panel or the SOURCE button on the remote control to select "AUX IN1" or "AUX IN2" mode.

Reset

After releasing the control panel, use a pencil or any non-metallic object to press and hold the RESET button for five seconds to reset the main unit. The unit will return to the factory default settings.

AUDIO MENU

Press the volume control button (4) to access the Audio Menu. You can navigate through the Audio Menu items by pressing the volume control button repeatedly. Once the desired menu item appears on the display, adjust that option by turning the audio control knob within 10 seconds. The unit will automatically exit the Audio Menu after six seconds of inactivity. The following menu items can be adjusted.

Bass Level (BAL)

Use the audio control knob to adjust the Bass level range from “-7” to “+7”.

Treble Level (TRE)

Use the audio control knob to adjust the Treble level range from “-7” to “+7”.

Balance (BAL)

Use the audio control knob to adjust the Balance between the right and left speakers from “R 7” (full right) to “L 7” (full left). “0” represents an equal balance between the right and left speakers.

Fader (FAD)

Use the audio control knob to adjust the Fader between the front and rear speakers from “R 7” (full rear) to “F 7” (full front). “0” represents an equal balance between the front and rear speakers.

NOTE: When the rear speaker is turned off, the fader option is disabled.

TUNER OPERATION

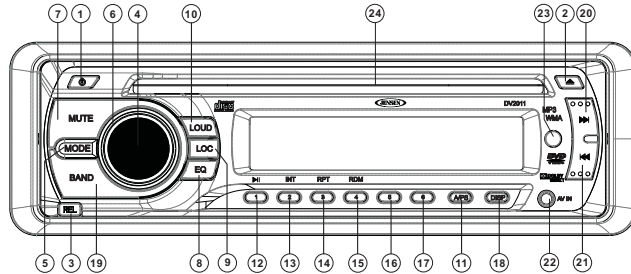

Select a Band

Press the **BAND** button (19) on the control panel (or the **SOURCE** button on the remote control) to change between three FM bands and two AM bands. Each band stores up to six preset stations.

Tuning

Manual Tuning

Press the up >>| (20) or down |<< button (21) for less than three seconds to enter seek tuning mode. Press the up >>| or down |<< button to change the radio frequency number up or down one step.

If using the remote control, press the **TUNE +** or **TUNE -** buttons to change the radio frequency number up or down one step.

Auto Seek Tuning

Press the up >>| (20) or down |<< button (21) for more than three seconds to move to the next station automatically.

Preset Stations

Six numbered preset buttons store and recall stations for each band.

Store a Station

Select a band (if needed), then select a station. *Press and hold* a preset button (12-17) for three seconds. The preset number will appear in the display.

Recall a Station

Select a band (if needed). Press a preset button (12-17) to select the corresponding stored station.

Automatically Store / Preset Scan

Automatically Store

Select a band (if needed). Press **A/PS** (11) for more than three seconds to automatically select six strong stations and store them in the current band. The new stations replace any stations already stored in that band.

Preset Scan

Select a band (if needed). Press **A/PS** (11) to scan stations stored in the current band. The unit will pause for ten seconds at each preset station. Press **A/PS** again to stop scanning when the desired station is reached.

Stereo

The unit will automatically pick up a stereo signal, when available. When in stereo mode, the "Ⓢ" icon appears in the display. When no stereo signal is available, the unit will automatically revert to mono operation, and no icon will be displayed.

AUDIO CD OPERATION

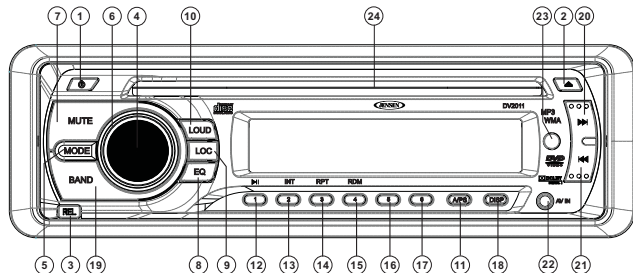





Insert and Eject Disc

Insert a disc into the disc slot (24), label-side up, with the unit turned on. The unit will play the first track on the disc. Press the eject  button (2) to stop disc play and eject the disc. The unit does not have to be turned on to eject the disc.



Controlling Disc Playback

Track Select



Press the up  (20) or down  button (21) for less than one second to advance to the next track on the CD. The selected track number will appear on the display. *Press and hold* the up  (20) or down  button (21) for more than 1 second to fast forward or fast reverse through the disc.

NOTE: When the last track finishes playing, the unit will automatically play the CD again.



Play/Pause Disc Playback (1/2)



Press the  button (12) on the control panel (or  on the remote control) to suspend disc play. Press the  button again to resume disc play.

Intro Scan (2 INT)



Press the  button (13) on the control panel to play the first 10 seconds of each track sequentially. Press  again to stop Intro Scan and resume normal play at the current track.

Repeat Play (3/RPT)

Press the  button (14) on the control panel (or the  button on the remote control) during disc play repeatedly to activate Repeat Mode:

- Press  once to turn repeat off.
- Press  twice to repeat play the current track.
- Press  three times to repeat play the whole disc.

Random Play (4/RDM)

Press the  button (15) during disc play to play all tracks on a CD in random, shuffled order. Press  again to stop random play.

MP3/WMA OPERATION

MP3 and WMA (Windows Media Audio) music files are digital audio files that are compressed to allow more files on a single CD. This unit can play MP3/WMA directly from files contained on a CD-R/RW using the buttons on the receiver (or optional remote) as described below. Many types of software are available for converting audio files into MP3/WMA formats. Jensen recommends *Nero*, *MusicMatch Jukebox* or *Roxio Easy CD Creator*. Depending on the media type and recording method, some CD-R/RW's may be incompatible with this unit. The unit supports playback of MP3/WMA and CDDA (CDA), Mixed-Mode CDs and CD-Extra (including multi-session discs), but **discs on which the session has not been closed will not play**.

Notes on MP3/WMA Play

This unit can play MP3 (MPEG1, 2, 2.5 Audio Layer 3) and WMA ver. 7 and 8. However, the MP3 recording media and accepted formats are limited. When writing MP3/WMA, pay attention to the following restrictions.

Acceptable Media

The MP3/WMA recording media acceptable to this unit are CD-ROM, CD-R and CD-RW. When using CD-RW, use full format rather than quick format to prevent malfunction.

Acceptable Medium Formats

The following formats are available for the media used in this unit. The maximum number of characters used for file name including the delimiter (".") and three-character extension are indicated in parentheses.

- ISO 9660 Level 1 (11 characters)
- ISO 9660 Level 2 (31 characters)
- Joliet (31 characters)

Up to 200 characters can be displayed in the long file name format. For a list of available characters, see the instruction manual of the writing software. The media reproducible on this unit has the following limitations:

- Maximum number of nested folders: 15
- Maximum number of files per disc: 796 (199 MP3+199 WMA+199 MPG+199 JPG)
- Maximum number of folders per disc: 199
- Maximum number of sessions per disc: 5

MP3/WMA written in formats other than those listed above will not play successfully and their file names or folder names will not be displayed properly.

MP3/WMA Encoder and CD Writer Settings

Use the following settings when compressing audio data in MP3 data with the MP3 encoder:

- Transfer bit rate: 32 - 320 kbps
- Sampling frequency: 32,44.1,48 kHz (WMA) 16,22.05,24,32,44.1, 48kHz (Mp3)

When using a CD writer to record MP3/WMA up to the maximum disc capacity, disable additional writing. To record an empty disc up to the maximum capacity at once, select the "disc at once" option.

Entering ID3 Tag

This unit supports ID3 tag versions 1.0 and 1.1.

Controlling Disc Playback

When a video monitor is installed, a screen similar to the following will appear when an MP3 disc is played.

1. Elapsed playing time
2. Total song length
3. Current transfer bit rate
4. Current action
5. Main folder
6. Current folder
7. Songs in current folder
8. Detail of Repeat mode.
9. Detailed song information

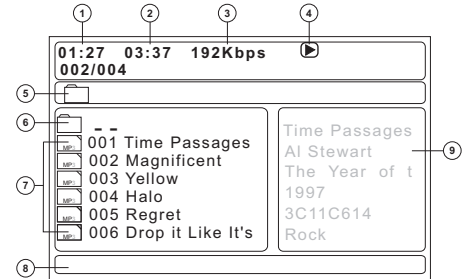

File Select

Press the up >>| (20) or down |<< button (21) for less than one second to advance to the next/previous file on the disc. Press and hold the >>| or |<< button repeatedly to fast forward or fast reverse through the disc at the rate of 2X, 4x, 8x, 16x, 32x. Normal playback will resume when the >|| button is pressed.

Play/Pause Disc Playback (1/>&||)

Press the 1/>&|| button (12) on the control panel (or >|| on the remote control) to suspend disc play. Press the 1/>&|| button again to resume disc Play.

Repeat Play (3/RPT)

Press the 3/RPT button (14) on the control panel (or the RPT button on the remote control) during disc play repeatedly to activate Repeat Mode:

- Press 3/RPT once to repeat play the current folder.
- Press 3/RPT twice to turn repeat off.
- Press 3/RPT three times to repeat play the current track.
- Press 3/RPT four times to repeat play the whole disc.

Random Play (4/RDM)

Press the 4/RDM button (15) during disc play to play all files on a disc in random, shuffled order. Press 4/RDM again to turn random play off.

DVD/DISC OPERATION

Once a DVD disc is inserted into the unit, the unit will automatically start playback from the beginning of the disc. Once the preview tracks have been played, the DVD MENU, ROOT or TITLE of the DVD disc will appear on the TFT monitor and "ROOT" will be displayed on the LCD panel. Press the **MENU** button on the remote control to bypass previews and access the root menu.

DVD Menu Button Functions

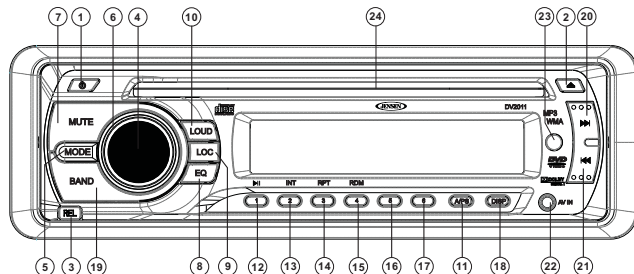

During DVD playback, you can use the following buttons to navigate the DVD, Root, or Title menu of the disc.

Control Panel

- Use the up >>| (20) button to move through introductory chapters and access the DVD menu.
- Press the 1/>| (12) button to choose the highlighted item on the menu.

Remote Control (see "Remote Control Operation" on page 8)

- Use the directional buttons (◀, ▶, ▲ and ▼) on the remote control to navigate the menu.
- Press the **ENTER** button to confirm the selected item.

Controlling Disc Playback

When viewing the DVD or Root Menu, press the 1/>| button (12) to choose the highlighted item on the menu. Once playback begins, the LCD will display the *Chapter: Playback Time* in the following format: "001 00:03".

Play/Pause Disc Playback (1/>|)

Press the 1/>| button (12) on the control panel (or the >| button on the remote control) to suspend disc play.

Stop Disc Playback (■)

Press the ■ button on the remote control to enter "RESUME STOP MODE." Press the >| button to resume playback from the previous location.

Press the ■ button twice consecutively to clear stop mode. With stop mode cleared, if the 1/>| button is pressed, the disc will resume playback from the beginning of the disc.

Chapter Select

Press the up >>| (20) or down <<| button (21) on the control panel or remote control to advance to the next or previous chapter on the disc.

Fast Forward/Reverse

Press the ►► or ◀◀ button on the remote control to fast forward or fast reverse through the disc. Keep pressing and releasing the button to increase the rate from 2X to 4X, 8X, 16X and 32X. Press >| on the remote control or 1/>| (12) on the control panel to resume normal playback.

NOTE: When playback of the last track has completed, the unit will automatically enter "STOP" mode. Press the >| or 1/>| button to start playback again.

Repeat Play (3/RPT)

Press the 3/RPT button (14) on the control panel (or the RPT button on the remote control) to select the repeat mode as follows:

DVD: CHAPTER > TITLE > ALL > REPEAT OFF

VCD/CD: REPEAT > TRACK > ALL

- Select CHAPTER to continuously repeat the current chapter.
- Select TITLE to continuously repeat the current title.
- Select TRACK to continuously repeat the current track.
- Select ALL to continuously repeat all chapters/tracks on the current disc. After playing the last chapter/track, the unit will stop and display the elapsed time.

NOTE: The REPEAT feature does not support VCD 2.0 (with PBC ON).

Menu Function (DVD Only)

Press the **MENU** button on the remote control while the disc is playing to display the disc root menu. You can navigate with the remote control navigation keys and select a feature using the **ENTER** button on the remote control.

Title Menu Function (DVD Only)

If the DVD has multiple titles recorded on the disc, you can select a specific title from the title menu from which to start playback.

1. Press the **TITLE** button on the remote control during playback to display the title menu.
2. Select the preferred title using the remote control arrow keys (29) and confirm by pressing the **ENTER** button.

PBC (Play Back Control) (VCD Only)

For VCDs with play back functionality, play back control (PBC) provides additional controls for VCD playback.

Press the **MENU** button on remote control to toggle the PBC function "On"/"Off". Once PBC is on, playback starts from track one of the play list.

NOTE: During VCD playback you can press the **LANG** button on the remote control during playback to switch the sound between mono and stereo sound in the following order: **MONO LEFT > MONO RIGHT > MIX MONO > STEREO.**

Remote Control Direct Track Entry

To select a track directly, use the number pad on the remote control. For single digit entries, press "0" followed by the single digit track number (for example, track 5 is entered as "05").

Goto Search

Perform the following steps to use the GOTO feature to access a specific location on a disc:

DVD Title/Chapter Search

To play a specific title/chapter:

1. Press the **GOTO** button. The on-screen display information will appear with the CHAPTER number highlighted (CHAPTER 00/00).
2. Use the arrow (<, >, ▲, ▼) buttons to move the cursor between the TITLE and CHAPTER fields.
3. Use the numeric buttons on the remote control to enter the desired title/chapter number.
4. Press the **ENTER** button.

DVD Time Search

To enter an exact playback starting point:

1. Press the **GOTO** button twice for TITLE time or three times for CHAPTER time.
2. Use the arrow (<, >, ▲, ▼) buttons to move the cursor through the TIME field (00:00:00).
3. Use the numeric buttons on the remote control to enter the playback starting point.
4. Press the **ENTER** button.

CD/VCD Disc/Track Search

Press the **GOTO** button once for DISC GO TO, twice for TRACK GO TO or three times for SELECT TRACK.

- Choose DISC GO TO to select an exact playback starting point relative to the total disc playing time.
- Choose TRACK GO TO to select an exact playback starting time within the current track.
- Choose SELECT TRACK to enter a specific track number for playback.

Use the arrow (<, >, ▲, ▼) buttons to move the cursor through the time field (00:00:00). Use the numeric buttons on the remote control to enter the playback starting point and then press the **ENTER** button.

Playing in Programmed Order

1. Press the **PROG** button to access the programmed playback screen. The DVD Program screen is displayed below:

PROGRAM:TT(08)/CH(-)

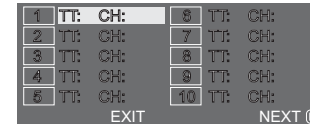

2. Use the arrow (<, >, ▲, ▼) buttons on the remote control to access the fields on the "PROGRAM" screen. Select "NEXT" to view a second screen of program fields (up to 20).
3. Use the number buttons on the remote control to enter a track number in each field.
 - a. For single digit entries, press "0" followed by the single digit track number (for example, track 5 is entered as "05").
 - b. The field will clear if the track or chapter number entered does not exist of the disc.
 - c. Press the >|| button on the remote control to clear current program entries and start over.
4. Choose the "START" option on screen to begin playback in the numbered order indicated.
5. Select "EXIT" to exit the programmed playback screen without beginning programmed playback.
6. To cancel "PROGRAM" playback, press the **PROG** button again and select "STOP".

NOTE: Programmed playback works for DVD, VCD and CD discs. The top bar on the screen is slightly different but the same instructions apply.

On-Screen Display Function

Press the display (□) button repeatedly during disc playback to view playback information at the top of the screen.

DVD Playback Information

Press once:	TITLE ELAPSED TT 01/08 Ch 02/16	0:41:43
Press twice:	TITLE Remain TT 01/08 Ch 02/16	0:30:00
Press three times:	CHAPTER Elapsed TT 01/08 Ch 02/16	0:02:15
Press four times:	CHAPTER Remain TT 01/08 Ch 02/16	0:01:55

- TT 01/08 – “01/08” indicates the first of 8 titles on the DVD is currently playing.
- Ch 02/16 – “02/16” indicates that the second of 16 chapters in the current title is currently playing.
- 0:41:43 – total elapsed or remaining playing time.

VCD/CD Playback Information

Press once:	SINGLE ELAPSED TRACK 01/08	01:22
Press twice:	SINGLE REMAIN TRACK 01/01	35:00
Press three times:	TOTAL ELAPSED TRACK 01/08	01:22
Press four times:	TOTAL REMAIN TRACK 01/01	40:22

- TRACK 01/08 – “01/08” indicates the first of 8 tracks on the VCD is currently playing.
- 01:22 – total elapsed or remaining playing time.

Display Subtitles (DVD/VCD Only)

If you are watching a disc recorded in multiple languages with subtitles, press the (□) button on the remote control to choose the language in which you would like the subtitles to appear. Continue pressing to select “SUBTITLE OFF” and turn off subtitles.

Multi-Language Discs (DVD Only)

If you are watching a disc recorded in multiple languages, press the **LANG** button on the remote control to choose a language. If no other languages are recorded, “⓪” is displayed in the top left corner of the screen.

Zoom

The Zoom function allows you to increase the picture size. Press the **ZOOM** button on the remote control to toggle from 2X to 3X to 4X scale and then to 1/2, 1/3 and 1/4 scale. When the scale is 1/4X, press **ZOOM** again to select OFF and cancel the Zoom function.

During Zoom mode, press the arrow buttons (<, >, ⏮, ⏭) to move the picture the up, down, left, or right.

NOTE: Zooming does not work on subtitles or menu screens included on DVDs.

Viewing an Alternate Picture Angle (DVD Only)

Some DVDs contain scenes that have been shot simultaneously from different angles. For discs recorded with multiple angles, press the **ANGLE** button on the remote control to toggle available angles of the on-screen image. If no other angles are recorded, “⓪” is displayed in the top left corner of the screen.

SYSTEM MENU

Press the (setup) button on the remote control to access the SYSTEM SETUP menu. Use the arrow (<, >) buttons to choose between from the following menu categories:

- General Setup
- Speaker Setup
- Dolby Digital Setup
- Video Setup
- Preference Setup

While in the setup menus, use the (<, >, \wedge , \vee) buttons (29) to select options and change settings.

1. Use the \wedge (up) / \vee (down) buttons to select the setting to be changed.
2. Press **ENTER** to cycle through each possible option or display a list of the options. When a list of options appears, press the \wedge (up) / \vee (down) buttons to move among the displayed options.
3. Press **ENTER** again to choose the option and change the setting.

General Setup Page

TV DISPLAY	NORMAL/PS
	NORMAL/LB
	WIDE
ANGLE MARK	ON/OFF
OSD LANG	ENGLISH
	FRENCH
	GERMAN
	SPANISH
	ITALIAN
	PORTUGUESE
CAPTIONS	ON/OFF
SCREEN SAVER	ON/OFF

- **TV DISPLAY:** The Display Mode can only be modified when the TV Display mode is set to 4:3.
 - **NORMAL/PS =** Take the maximum value of horizontally fit scale ratio and vertically fit scale ratio.
 - **NORMAL/LB:** Take the minimum value of horizontally fit scale ratio and vertically fit scale ratio.
 - **WIDE:** The 16:9 options is used when the DVD player is connected to a wide screen TV in Full Mode - the screen will display pictures in full size.
- **ANGLE MARK:** Mark multi-angle scenes.

- **OSD LANG:** Select the setup menu and OSD (On-screen Display) language used during the disc playback and instructional operations. The language selection includes: English, Spanish, Greek, Swedish, Dutch, Italian, and Poland. Some DVDs may not include the pre-selected language. In this case, the player automatically displays menus consistent with the disc's initial language setting.
- **CAPTIONS:** Turn on-screen captioning on/off.
- **SCREEN SAVER:** Turn the screen saver on/off. The screen saver activates after 330 seconds.

Speaker Setup Page

DOWNMIX	LT/RT
	STEREO

- **DOWNMIX:** Distinct audio channels are mixed to produce a lower number of channels.

Dolby Digital Setup

DUAL MONO	STEREO
	L-MONO
	R-MONO
	MIX-MONO

- **DUAL MONO:** Output mono audio to both channels.

Video Setup Page

SHARPNESS	HIGH
	MEDIUM
	LOW
BRIGHTNESS	-20 TO + 20
CONTRAST	-16 TO + 16

- **SHARPNESS:** Adjust the video screen sharpness to a predetermined HIGH, MEDIUM or LOW setting.
- **BRIGHTNESS:** Adjust the video screen brightness from -20 (least bright) to +20 (brightest).
- **CONTRAST:** Adjust the video screen contrast from -20 (least contrast) to +20 (most contrast).

Preference Page

TV TYPE	PAL
	AUTO
	NTSC
AUDIO	ENGLISH
	FRENCH
	GERMAN
	SPANISH
	ITALIAN
	PORTUGUESE
	THAI
SUBTITLE	ENGLISH
	FRENCH
	GERMAN
	SPANISH
	ITALIAN
	PORTUGUESE
	OTHERS
DISC MENU	ENGLISH
	FRENCH
	GERMAN
	SPANISH
	ITALIAN
	PORTUGUESE
PARENTAL	See PARENTAL notes.
PASSWORD	CHANGE
DEFAULT	RESET

- **TV TYPE:** Select from the following Video output options: PAL, NTSC, or Auto default.
- **AUDIO:** When DVD disc playback begins, this unit will automatically select the default audio language of the unit. Please note that if the language recorded in the disc is not available in

the language list on the disc menu, the language originally recorded on the disc will be used. If the disc is equipped with a specific playback language, this specific language will be used.

- **SUBTITLE:** Select a preferred subtitle language (DVD only). Some DVDs may be set to display subtitles in a different language than selected.
- **DISC MENU:** Set a default playback language value for the DVD Menu display. Some DVD menus may appear in a different language than selected.
- **PARENTAL:** Selecting a Rating allows the user to set the parental control feature of the player. Rating can only be changed when the password is unlocked. Press **ENTER** to cycle through the following options:
 - Kid Safe = Only titles with a parental control setting of 1 are allowed to play
 - G = Only titles with a parental control setting of 2 or less are allowed to play
 - PG = Only titles with a parental control setting of 3 or less are allowed to play
 - PG-13 = Only titles with a parental control setting of 4 or less are allowed to Play
 - PG-R = Only titles with a parental control setting of 5 or less are allowed to play
 - R = Only titles with a parental control setting of 6 or less are allowed to play
 - NC-17 = Only titles with a parental control setting of 7 or less are allowed to play
 - Adult = Allow any title to play (factory default)

NOTE: Parental Control functions only if the DVD title has it encoded in its program. Parental control does not work for VCD/SVCD/CVD or CD Audio.

- **PASSWORD:** The Password item is used to set a new password to lock and unlock the parental control rating setting into the player. To change the password, use the remote control number pad to enter the default (1369) or current password and repeat to confirm. Next, enter the new password and select "OK" to confirm. You must now enter the new password to view programs blocked by the "PARENTAL" setting or to make changes to parental settings.

NOTE: If the password is forgotten, the "back-door" password 1369 will unlock the parental control.

Exiting the Setup Menu

Press the  (setup) button on the remote control or wait a few seconds to exit the System Setup menu and resume DVD playback.

TROUBLESHOOTING

Symptom	Cause	Solution
No power	The vehicle ignition is not on	If the power supply is properly connected to the vehicle accessory terminal, switch the ignition key to "ACC".
	The fuse is blown	Replace the fuse.
Disc cannot be loaded or ejected	Presence of CD disc inside the player	Remove the disc in the player and insert the new one.
	Inserting the disc in reverse direction	Insert the compact disc with the label facing upward.
	Compact disc is extremely dirty or disc is defective	Clean the disc or try to play a new one.
	Temperature inside the vehicle is too high	Wait until the ambient temperature returns to normal.
	Condensation	Leave the player off for an hour or so, then try again.
No sound	Volume is too low	Adjust volume to audible level.
	Wiring is not properly connected	Check wiring connections.
The operation keys do not work	Control panel not properly installed	Reinstall control panel.
	The built-in microcomputer is not operating properly due to noise	Press the RESET button.
Sound skips	The installation angle is more than 30 degrees	Adjust the installation angle to less than 30 degrees.
	The disc is dirty or defective	Clean the disc and try to play again or use new disc.
Cannot tune to radio station, auto-seek does not work	The antenna cable is not connected	Insert the antenna cable firmly.
	The signals are too weak	Select a station manually.
ERROR	Mechanism Error	Press the eject button to correct the problem. If the error code does not disappear, consult your nearest service dealer.
Disc Error	Disc is dirty/scratched/ upside down	Replace the disc.

SPECIFICATIONS

DVD/CD

Signal to Noise Ratio ≥ 90 dB
 Dynamic Range ≥ 90 dB
 Frequency Response 20Hz to 20KHz +/- 3dB
 Channel Separation 2 Channel (Stereo) > 60dB @ 1KHz

Video

Color System NTSC/PAL
 Video Output Composite 1.0 Vp-p (+/- 0.2) 75 - ohm
 Video Input Composite 1.0 Vp-p (+/- 0.2) 75 - ohm

Audio

Max Output Power 40W x 4 channels
 Load Impedance (speakers) 4 ohms
 Line Out Level/Load 400mV/10k ohm load
 Line Out Impedance 200 ohm

Auxiliary Input

Frequency Response 20Hz to 20KHz ± 3 dB
 Input Maximum Voltage 1200mV
 Input Impedance 4.7k ohm

FM Radio

Frequency Range 87.5-107.9 MHz (200 kHz Space)
 Usable Sensitivity ≤ 15 dB at S/N 30 dBu
 Stereo Separation ≥ 25 dB at 1KHz
 S/N Ratio ≥ 50 dB

AM/MW

Frequency Range 530-1710 (10 kHz Space)
 Usable Sensitivity ≤ 40 dB at S/N 20dBu
 S/N Ratio ≥ 40 dB

General

Operating Voltage DC 11 -14.4V
 Grounding System Negative Ground
 Fuse 15-Amp Mini ATM Type
 Operating Temperature 0°C to 50°C
 Unit Mounting Angle < 30°



ASA Electronics Corporation

www.asaelectronics.com

www.jensenrvidirect.com

©2010 ASA Electronics Corporation

v.123010

